



WORKFORCE OF
5,500+ DEDICATED EMPLOYEES
WITH 400+ ENGINEERS IN R&D



AMONG TOP **5** TRACTOR
MANUFACTURERS
GLOBALLY*



NO. 1
TRACTOR EXPORTER
FROM INDIA



SOLD IN
150+ COUNTRIES
WORLDWIDE



Tough. Rugged. Value



INTERNATIONAL TRACTORS USA CORPORATION

2332 Mt. Zion Rd, Greenwood, Arkansas-72936, USA,
Phone no.+1 (514) 850-9580 | Website: www.solistractorusa.com
Call Now- 514 850 9580



SCAN ME



www.solistractorusa.com

WORLD'S NO.1 INTEGRATED MANUFACTURING PLANT



ROBOTIC PAINTSHOP



ROBOTIC GEAR SHOP



ROBOTIC WELDING



Solis has established World's No.1 integrated Tractor manufacturing plant in Hoshiarpur, Punjab with a production capacity of 300,000 Tractor annually. The plant is widely spread across many acres and has 10 different manufacturing units which produces heavy duty

tractor range of Solis. The quality of the output is because of the highly professional and skilled manpower, with their core as most effectiveness. Thus the manufacturing plant provides a complete solution to "Total Customer Satisfaction."



SOLIS IS SOLD IN **150+** COUNTRIES

SOLIS IS THE MARKET LEADER IN **10+** COUNTRIES*

Tough . Rugged . Value



MORE THAN 1.4 MILLION

SATISFIED CUSTOMERS WORLDWIDE

BEHOLD THE COMPACT SERIES



- S24 - MANUAL DRIVE 24HP ENGINE
- S24 Shuttle XL - MANUAL DRIVE 24HP ENGINE
- H24 - HST ROPS - 24HP ENGINE
- H24 - HST CABIN - 24HP ENGINE

COMFORT

Our tractor has a "Best-in-class" Wide Flat platform workspace, providing a wider entry for easier entry and exit.

Our unique, new style fenders have integrated levers, and our strong footstep allows you to board easily and comfortably. On the left side of the operator seat, Solis 24HST has a Range Lever, a PTO Lever, a 2WD/4WD, and a Differential Lock which are easy to operate with less effort.

On the right side, the Solis 24HST has an Aviation style Position Lever & DCV Lever. The ergonomically located break pedal is on the left side of the operator. Our twin HST pedal, for Forward & Reverse provide fatigue-free operation. Solis 24HST has foldable ROPS to allow you to work in low-height fields.

QUALITY

The Solis 24HST, has a Japanese Technology based Hydrostatic Transmission, which is very efficient and very smooth. The Solis HST is super easy to operate with responsive twin pedals, where one is for forward and the other for reverse. The Solis 24HST has a Cruise Control feature to reduce fatigue. The Solis 24HST is powered by a Tier 4 Mitsubishi Engine, with our Heavy Duty Transmission, it provides you reliable, long work sessions. Our Single Piece Hood is designed to be very durable that can withstand rough and tough work conditions.

VERSATILITY

The Solis Compact Series is a complete range of tractors that can help you with your lawn, garden, and even small farm. Our Solis Front End Loaders have the highest lift capacity (at the pivot point) in their class. The wide variety of Accessories that we offer ensure, you accomplish every job on your property.



COMFORT





H24
CABIN

STANDARD EQUIPMENT FOR CABIN

- Heater Cabin
- Wide Operator Platform
- Mid & Rear PTO
- 2-Stage Opening Rear Window
- Cab Interior Light
- Cruise Control
- Radio Ready
- Front and Rear LED Work Lights
- Side Mirrors
- Deluxe Suspension Seat
- Front & Rear Wiper
- Floor Mat
- Cup Holder
- Integrated Loader Joystick



SPACIOUS & COMFORTABLE CABIN

The Compact Series delivers incredible comfort for the operator, courtesy of our new integrated cab. The Four Pillar design gives you extra space and a great view of your work area. Our door entry is broad, allowing ease of entrance and exit.

STYLISH PROJECTOR HEAD LIGHTS

Our stylish EPA compliant projector head lamps project a high intensity, focused, wide spread beam. As a result, you may comfortably continue your work until well after dark.



COMFORT

Our large cab provides you a panoramic view. Our ergonomically placed levers are designed to enhance your user experience and ease operations, all with the goal of making it more efficient and productive for you.



H24
ROPS

VERSATILE OPERATIONS

Our tractors provide you with a versatile, efficient platform for accomplishing a wide array of tasks: loading, mowing, towing, and so much more.

STANDARD EQUIPMENT FOR OUR OPEN STATION MODEL

- Deluxe Seat with Arm Rests
- Cruise Control
- Wide Flat Platform Area
- 1DA External Hydraulic Port with Detent Feature
- Floor Mat
- Cup Holder
- Integrated Loader Joystick
- Lower Link Stabilizer
- Button Operated Wet PTO

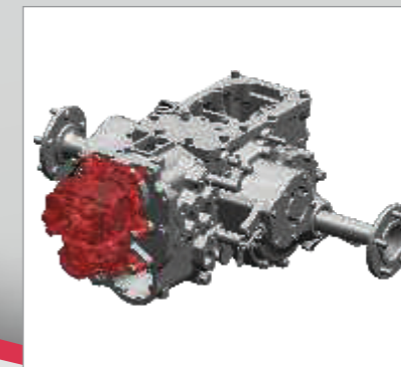

COMFORT The New H24 ROPS

Our Compact Series is designed to meet your work challenge. We help you do your work efficiently.

Our "All Day Comfort Seat" will allow you to work long days, and ensure you remain comfortable even during your toughest jobs.

Our clutchless Hydrostatic Transmission allows for easy operation, and is designed to provide the optimal speed suited to your task.

Our control levers are strategically placed for easy access, on both our right and left consoles. Further, our switches are conveniently located near our instrument panel.

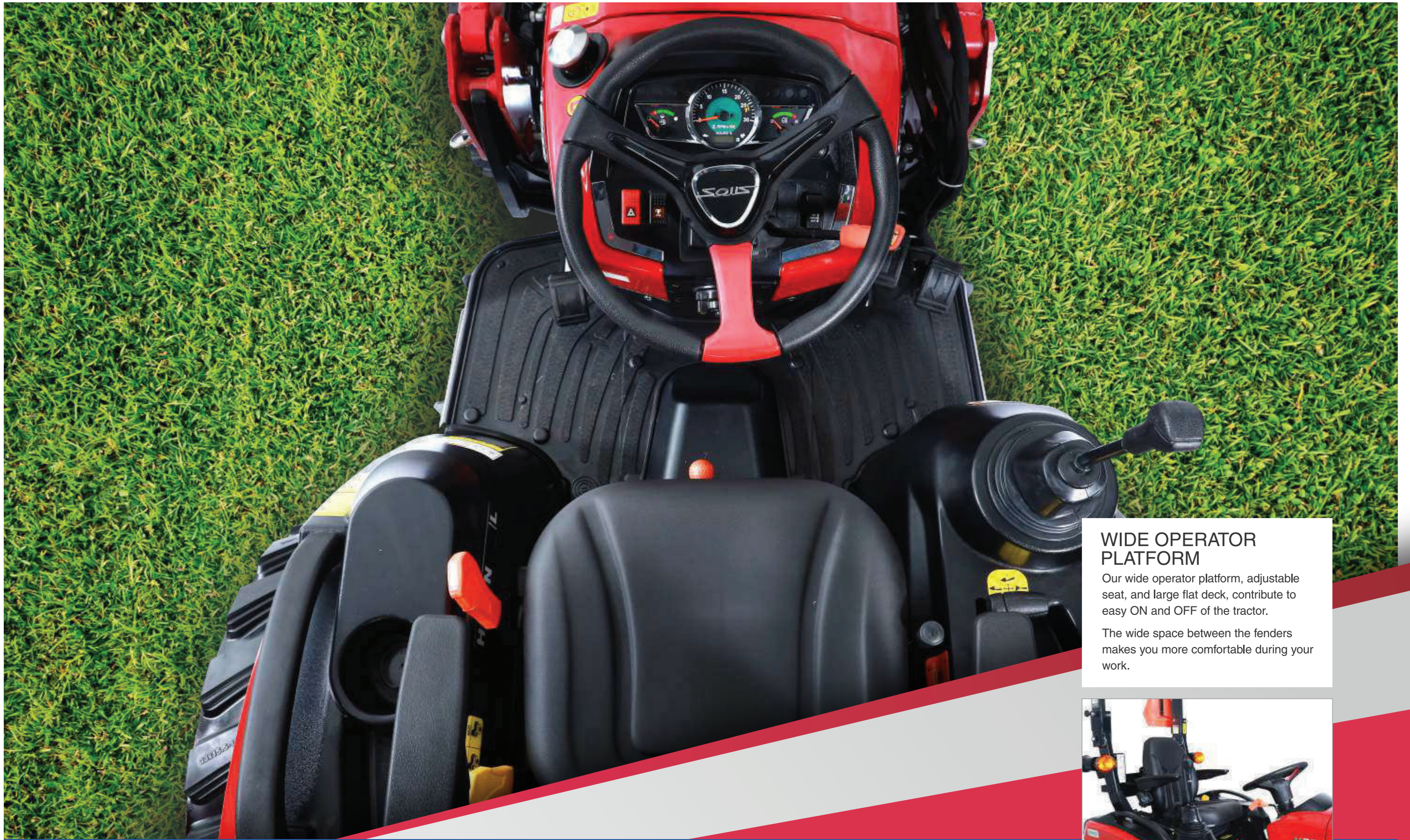

WIDE OPERATOR PLATFORM

Our wide operator platform, adjustable seat, and large flat deck, contribute to easy ON and OFF of the tractor.

The wide space between the fenders makes you more comfortable during your work.



H24 - POWER AND COMFORTS

Our Compact Series is the ultimate solution for the job, offering so many Accessories to help you get your job finished.

SPECIAL UTILITY MODEL FEATURES

- Flat Operator Platform
- Deluxe Seat
- Integrated Loader Joystick
- Cup Holder
- Floor Mat
- Mid-PTO
- Cruise Control
- Footstep at Both Sides

QUALITY

DURABILITY

Our Solis Compact Series gives you peace of mind. Our Solis tractors are tough and durable, and will work hard for you, season after season.

QUICK CLEANING

EASY MAINTENANCE



Easy Maintenance with One-Piece Metal Hood

Our headlamps and grill are integrated into the hood, which allows for easy opening and closing of the hood, and easy access for the engine.



Heavy Duty Transmission

Solis tractor transmissions are strong, and they last. Our powerful 4WD axle allows you to tackle tough conditions in the field. Our tight turning radius lets you turn in less space, smoothly. Our front tow hook will come in handy, too.



MITSUBISHI DIESEL ENGINE: RELIABLE AND ADVANCED

Solis is equipped with the reliable Mitsubishi Engine, coupled with a Japanese HST transmission, this provides a super tough combination. Solis tractors deliver quality and durability, making your tractor a long-term investment. Fuel economy is unmatched.

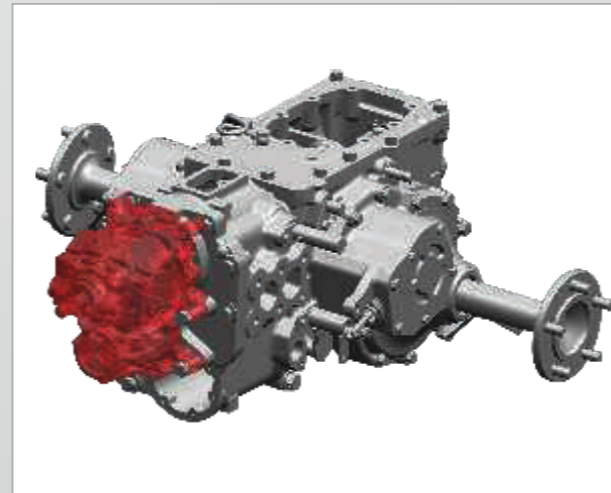

JAPANESE HST TRANSMISSION

Solis HST is super easy to operate with responsive twin pedals, one for forward and the other for reverse. Solis 24HST has a Cruise Control feature for fatigue free operation. The brakes are oil immersed for smoother functioning, and advanced safety features ensure that your farming experience is safe.



QUALITY

Solis is the top-selling compact tractor brand in Europe in the 24HP segment, and now it is available in the United States and Canada. Solis journey to become a worldwide player in the tractor business began 25 years ago. Over these past few decades, Solis has built its reputation on performance, quality, value, and trust. Solis tractors are sold in over 150+ countries across the globe.

H24

(Hydrostatic)

OPEN STATION TRACTOR



STANDARD HYDRAULIC REAR REMOTES



STANDARD FLOOR MAT



CRUISE CONTROL



INTEGRATED LOADER JOYSTICK



STANDARD PROJECTOR HEADLAMPS



STANDARD SEAT WITH ARM REST

ALL STANDARD FEATURES



STANDARD MID PTO



100% METAL HOOD



STANDARD REAR SWING DRAWBAR



STANDARD FRONT TOW HOOK

SPECIFICATIONS

FEATURES	H24
ENGINE	
Engine Model	Mitsubishi S3L2
HP Category	24
No. of Cylinder	3
Aspiration	Natural
Cubic Capacity (Ci)	80.42
Rated RPM	2500
Max Torque	76.3Nm@2000
TRANSMISSION	
Drive	4WD
Forward/Reverse Controls	Twin Touch Pedals
Gearbox	HST (2 Range)
Transmission Type	Constant Mesh
Cruise Control	Yes
BRAKES	
Type	Oil Immersed Brakes
Type of Actuation	Mechanical, Foot Operated
Differential Lock	Standard
PTO	
PTO (RPM)	Rear - 540@2451 Mid PTO - 2100@2438
PTO Clutch	Wet Type
PTO Actuation	Button Operated
Steering	Power Steering
HYDRAULICS	
3 Point Linkages	CAT1N
3 Point Lifting Capacity@Ball Ends (lbs)	1323
Aux Hydraulic Circuit	1DA (Detent with Float)
Total Hydraulic Flow (GPM)	3.98
CAPACITY	
Fuel Tank (gal)	7
DIMENSIONS & WEIGHT (AGRI TIRES)	
Weight (lbs)	2513
Wheel Base (in)	61.8
Total Length with TPL (in)	113.98
Total Width (in)	47.83
Height (in) upto ROPS	91.53
Ground Clearance	9.44 (Front Axle)

FEATURES	H24
TIRES	
Industrial	23x8.50-12 & 33x15.5-16.5
Turf	23x8.50-12 & 33x15.5-16.5
Turf	25x8.50-14 & 13.6x16
Agri	6x12 & 8.3x20
Agri	7x14 & 8.3x24
Radial	6.5/80-12 & 280/70R18
Galaxy Pro	220/55 R12 & 280/70 R16
R14	23x8.50-12 R14T & 12-16.5 R14T

*Data and specifications are subject to change without any advance notice due to continuous product improvement and development. All dimensions are with standard tires.

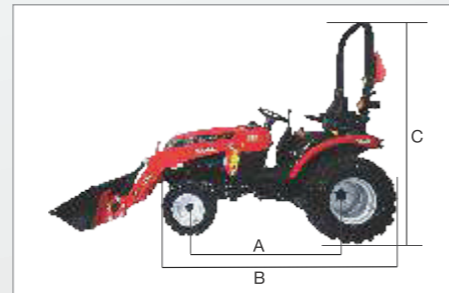

DIMENSION CHART

	H24 (Industrial Tire)
A	61.81
B	114
C	91
D	37.20
E	45.27
F	61
G	9.44

COMFORT WITH HYDROSTATIC TRANSMISSION

Our comfortable seat and wide flat platform workspace, coupled with our Hydrostatic Transmission (HST) are made for easy performance in a wide variety of conditions.

Solis 24 HST

Loader Model	HL24-N	HL24-M	3200
NSL/MSL	NSL	MSL	NSL/MSL
Max Lifting Height at Pivot Point (in)	82	82	85
Clearance with Attachment Dump (in)	61	61	61
Reach at Maximum Height (in)	33	34	17
Reach at Bucket on Ground (in)	63	63	56
Max. Dump Angle (deg.)	44	42	45
Attachment Rollback Angle (deg.)	31	41	43
Digging Depth Below Grade (in)	2.5	2.5	5.9
Breakout Force at Pivot Point (Dig Position) (lbs)	1565	1477	1058
Bucket Width (in)	48	48	52
Lifting Capacity to Full Height at Pivot Point (lbs)	1500	1102	926



Heavy duty tractor, weight 2513 lbs (without loader)

SPECIFICATIONS

FEATURES	H24 CABIN
ENGINE	
Engine Model	Mitsubishi S3L2
HP Category	24
No. of Cylinder	3
Aspiration	Natural
Cubic Capacity (Ci)	80,42
Rated RPM	2500
Max Torque	76.3Nm@2000
TRANSMISSION	
Drive	4WD
Forward/Reverse Controls	Twin Touch Pedals
Gearbox	HST (2 Range)
Transmission Type	Constant Mesh
Cruise Control	Yes
BRAKES	
Type	Oil Immersed Brakes
Type of Actuation	Mechanical, Foot Operated
Differential Lock	Standard
PTO	
PTO (RPM)	Rear - 540@2451 Mid PTO - 2100@2438
PTO Clutch	Wet Type
PTO Actuation	Button Operated
Steering	Power Steering
HYDRAULICS	
3 Point Linkages	CAT1N
3 Point Lifting Capacity@Ball Ends (lbs)	1323
Aux Hydraulic Circuit	1DA (Detent with Float)
Total Hydraulic Flow (GPM)	3.98
CAPACITY	
Fuel Tank (gal)	7
DIMENSIONS & WEIGHT (AGRI TIRES)	
Weight (lbs)	2775.62
Wheel Base (in)	61.8
Total Length with TPL (in)	113.98
Total Width (in)	49
Height (in) upto ROPS	84
Ground Clearance	9.44 (Front Axle)

FEATURES	H24 CABIN
TIRES	
Industrial	23x8.50-12 & 33x15.5-16.5
Turf	23x8.50-12 & 33x15.5-16.5
Turf	25x8.50-14 & 13.6x16
Agri	6x12 & 8.3x20
Agri	7x14 & 8.3x24
Radial	6.5/80-12 & 280/70R 18
Galaxy Pro	220/55 R12 & 280/70 R16
R14	23x8.50-12 R14T & 12-16.5 R14T

*Data and specifications are subject to change without any advance notice due to continuous product improvement and development. All dimensions are with standard tires.

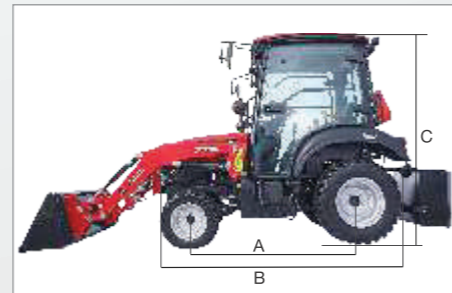

DIMENSION CHART

	H24 (Industrial Tire)
A	61.81
B	114
C	83.5
D	37.2
E	45.27
F	61
G	9.44

MORE SPACE FOR EXTRA COMFORT

Discover the unmatched comfort with the Four Pillar Design that results in extra space providing you a great view of your work area. Operators can enjoy added ease with the new integrated cab. Enjoy comfortable entry and exit with the broad door entry.

Solis 24 HST

Loader Model	HL24-N	HL24-M	3200
NSL/MSL	NSL	MSL	NSL/MSL
Max Lifting Height at Pivot Point (in)	82	82	85
Clearance with Attachment Dump (in)	61	61	61
Reach at Maximum Height (in)	33	34	17
Reach at Bucket on Ground (in)	63	63	56
Max. Dump Angle (deg.)	44	42	45
Attachment Rollback Angle (deg.)	31	41	43
Digging Depth Below Grade (in)	2.5	2.5	5.9
Breakout Force at Pivot Point (Dig Position) (lbs)	1565	1477	1058
Bucket Width (in)	48	48	52
Lifting Capacity to Full Height at Pivot Point (lbs)	1500	1102	926





WIDE OPERATOR PLATFORM

Our wide operator platform, adjustable seat, and large flat deck, contribute to easy ON and OFF of the tractor.

The wide space between the fenders makes you more comfortable during your work.



S 24 XL - POWER AND COMFORTS

Our Compact Series is the ultimate solution for the job, offering so many Accessories to help you get your job finished.

SPECIAL UTILITY MODEL FEATURES

- Flat Operator Platform
- Deluxe Seat
- Integrated Loader Joystick
- Cup Holder
- Floor Mat
- 9F+9R Transmission
- Footstep at Both Sides

24 Shuttle XL

(Manual Drive)

VERSATILE PERFORMER



STANDARD FLOOR MAT



STANDARD STYLISH STEERING WHEEL



SHUTTLE (FORWARD/REVERSE)



9 FORWARD AND 9 REVERSE SPEEDS TRANSMISSION



STANDARD PROJECTOR HEADLAMPS

STANDARD SEAT WITH ARM REST

ALL STANDARD FEATURES



STANDARD HYDRAULIC REAR REMOTES



100% METAL HOOD



STANDARD REAR SWING DRAWBAR



STANDARD FRONT TOW HOOK

SPECIFICATIONS

FEATURES	S24 Shuttle XL
ENGINE	
Engine Model	Mitsubishi S3L2
HP Category	24
No. of Cylinder	3
Aspiration	Natural
Cubic Capacity (Ci)	80.42
Rated RPM	2500
Max Torque	76.3 Nm@2000
TRANSMISSION	
Drive	4WD
Forward/Reverse Lever	Synchromesh Shuttle Lever on Dashboard
Gearbox	9+9
Transmission Type	Constant Mesh with Synchromesh Shuttle Transmission
Cruise Control	Yes
BRAKES	
Type	Oil Immersed Brakes
Type of Actuation	Mechanical, Foot Operated
Differential Lock	Standard
PTO	
PTO (RPM)	540/540E
PTO Actuation	Mechanical
Steering	Power Steering
HYDRAULICS	
3 Point Linkages	CAT1N
3 Point Lifting Capacity@Ball Ends (lbs)	1323
Aux Hydraulic Circuit	1DA (Detent with Float)
Total Hydraulic Flow (GPM)	6.5
CAPACITY	
Fuel Tank (gal)	5.8
DIMENSIONS & WEIGHT (AGRI TIRES)	
Weight (lbs)	2513
Wheel Base (in)	61.8
Total Length with TPL (in)	113.98
Total Width (in)	47.83
Height (in) upto ROPS	91.53
Ground Clearance	9.44 (Front Axle)

FEATURES	S24 Shuttle XL
TIRES	
Industrial	23x8.50-12 & 33x15.5-16.5
Turf	23x8.50-12 & 33x15.5-16.5
Turf	25x8.50-14 & 13.6x16
Agri	6x12 & 8.3x20
Agri	7x14 & 8.3x24
Radial	6.5/80-12 & 280/70R 18
Galaxy Pro	220/55 R12 & 280/70 R16
R14	23x8.50-12 R14T & 12-16.5 R14T

*Data and specifications are subject to change without any advance notice due to continuous product improvement and development. All dimensions are with standard tires.

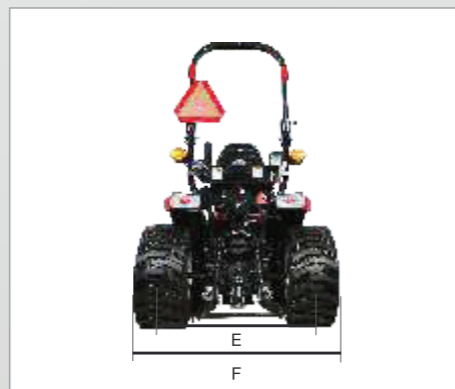
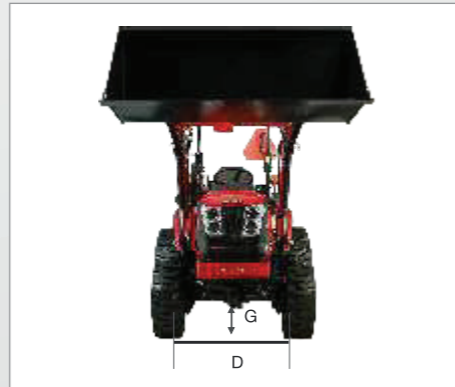
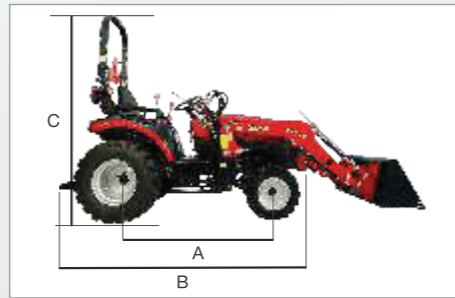

DIMENSION CHART

	S24 Shuttle XL (Industrial Tire)
A	61.8
B	113.98
C	91.53
D	37.40
E	45.27
F	61.8
G	9.44

VERSATILE PERFORMER

Solis 24 XL (9+9)

Loader Model	XL24-N	XL24-N	3200 V
NSL/MSL	NSL	MSL	NSL/MSL
Max Lifting Height at Pivot Point (in)	82	82	85
Clearance with Attachment Dump (in)	61	61	58
Reach at Maximum Height (in)	33	34	17
Reach at Bucket on Ground (in)	63	63	56
Max. Dump Angle (deg.)	44	42	45
Attachment Rollback Angle (deg.)	31	41	43
Digging Depth Below Grade (in)	2.5	2.5	5.9
Breakout Force at Pivot Point (Dig Position) (lbs)	1565	1477	1146
Bucket Width (in)	48	48	52
Lifting Capacity to Full Height at Pivot Point (lbs)	1500	1102	1411



Heavy duty tractor, weight 2513 lbs (without loader)

S24

(Manual Drive)

VERSATILE PERFORMER



STANDARD HYDRAULIC REAR REMOTES



STANDARD FLOOR MAT



STANDARD TOOL BOX



HEAVY DUTY FRONT AXLE



STANDARD PROJECTOR HEADLAMPS



HEAVY DUTY FRONT LOADER

ALL STANDARD FEATURES



STANDARD GRAB RAILS



STANDARD REAR SWING DRAWBAR



100% METAL HOOD



STANDARD FRONT TOW HOOK

SPECIFICATIONS

FEATURES		S24
ENGINE		
Engine Model	Mitsubishi S3L2	
HP Category	24	
No. of Cylinder	3	
Aspiration	Natural	
Cubic Capacity (Ci)	80.42	
Rated RPM	2500	
Torque	76.2 Nm@2000	
TRANSMISSION		
Drive	4WD	
Clutch	Single	
Gearbox	6F+2R	
BRAKES		
Type	Oil Immersed Brakes	
Type of Actuation	Mechanical, Foot Operated	
Differential Lock	Standard	
PTO		
PTO (RPM)	540@2491	
PTO Actuation	Mechanical	
Steering	Power Steering	
HYDRAULICS		
3 Point Linkages	CAT1N	
3 Point Lifting Capacity@Ball Ends (lbs)	1323	
Aux Hydraulic Circuit	1DA	
Total Hydraulic Flow (GPM)	3.27	
CAPACITY		
Fuel Tank (gal)	7	
DIMENSIONS & WEIGHT (AGRI TIRES)		
Weight (lbs)	2292.80	
Wheel Base (in)	61.4	
Total Length (in)	108.66	
Total Width (in)	42.32	
Height (in) upto ROPS	84.34	
Ground Clearance (in)	9.44 (Front Axle)	

FEATURES		S24
TIRES		
Industrial	23x8.50-12 & 33x15.5-16.5	
Turf	23x8.50-12 & 33x15.5-16.5	
Agri	6x12 & 8.3x20	
Agri	7x14 & 8.3x24	
Radial	6.5/80-12 & 280/70R18	
Galaxy Pro	220/55R12 & 280/70R16	
R14	23x8.50-12 R14T & 12-16.5 R14T	

*Data and specifications are subject to change without any advance notice due to continuous product improvement and development. All dimensions are with standard tires.

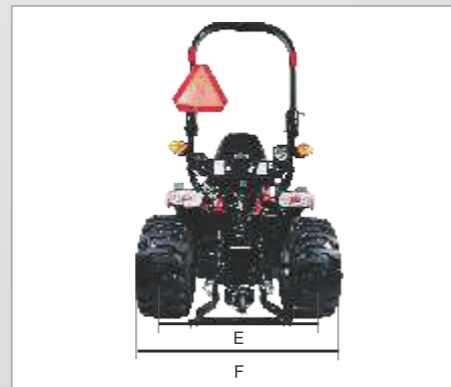
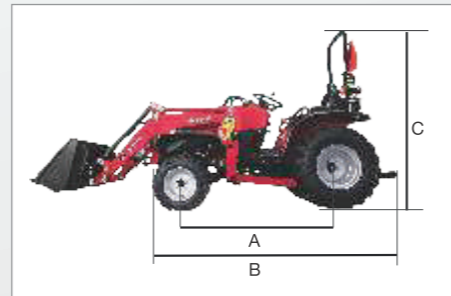

DIMENSION CHART

	S24 (Industrial Tire)
A	61.41
B	108.66
C	76.37
D	37.40
E	39.56
F	55.90
G	9.44

VERSATILE PERFORMER

Solis 24 (6+2)

Loader Model	3200	3200 V
NSL/MSL	NSL/MSL	NSL/MSL
Max Lifting Height at Pivot Point (in)	85	85
Clearance with Attachment Dump (in)	61	58
Reach at Maximum Height (in)	17	17
Reach at Bucket on Ground (in)	56	56
Max. Dump Angle (deg.)	45	45
Attachment Rollback Angle (deg.)	43	43
Digging Depth Below Grade (in)	5.9	5.9
Breakout Force at Pivot Point (Dig Position) (lbs)	1058	1146
Bucket Width (in)	52	52
Lifting Capacity to Full Height at Pivot Point (lbs)	926	1411



Heavy duty tractor, weight 2293 lbs (without loader)

VERSATILITY





LOADER ACCESSORIES OPTIONS AVAILABLE



Log Bucket



Fork Frame



Grapples



Stick Rakes for
Front End Loaders



4-in-1
(Requires 3rd Function)

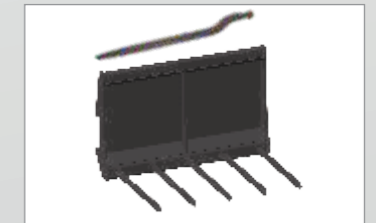

Manure Forks

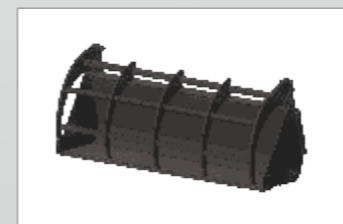

Shear Grabs

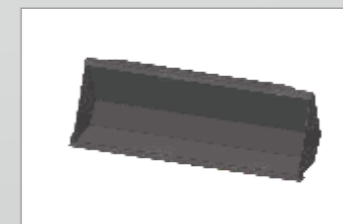

Standard Bucket



Blade with Mesh Guard
for Front End Loaders



3rd Function Kit Accessories
as an option

VERSATILITY

Solis Compact Series is designed to handle material, excavating, snow removal, and mowing along with many other applications and day-to-day tasks. Solis offers end-to-end, plug-and-play implements and attachments to take on your various projects.



Rotary Tiller



Grooming Mower



Mid-Mount Mower



Rotary Slasher



Box Blade

VERSATILE OPTIONS

Solis Compact Series is designed for the best performance across a wide variety of tasks, including tilling, grading, shredding, mowing and snow removal.

TIRE OPTIONS

Solis Compact Series comes with a wide range of tires for tough tasks requiring heavy-duty performance.



Agri Tire



Radial Agri



Turf



Industrial



Galaxy Pro



R14